

SCENIC GLASS BALUSTER INSTALLATION INSTRUCTIONS (CONNECTORS)

Kit Contents:

- 5 - Glass balusters
- 20 - Stainless steel screws
(You will need 1.5 balusters per linear foot of handrail.)

Items You Will Need:

- Drill driver
- Tape measure
- 2-pt. square head drill bit
- Safety glasses
- Carpenter's pencil
- Clamps
- Support blocks (can be cut from scrap rail material)
- Scenic baluster connectors (sold separately)
- Scenic baluster stair connectors (sold separately)

Prior to construction, check with your local regulatory agency for special code requirements in your area. Common railing height is 36" or 42". Structural support should come from either the continuation of deck support posts that extend up through the deck floor or from railing posts that are bolted to the inside of the rim or outer joist. **6' on-center spacing is recommended. Never span more than 8' between railing posts.**

Installation Instructions:

INLINE RAILING

Step 1: Measure railing opening from post to post to determine the length of each rail section.

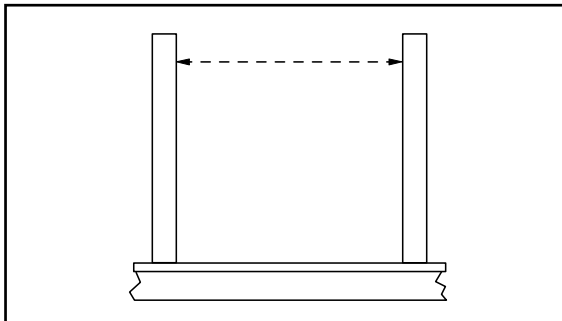

Step 2: Cut top and bottom rails to the proper length and clamp together. Locate the center of the rails and mark. If using an odd number of balusters, the balusters will start at the center of the rail. For Frontier Balusters: If using an even number of balusters, the balusters will start 3-3/4" either side of center, with all balusters 7-1/2" on-center. Mark both rails 7-1/2" on-center, starting from the desired location. For Contour Balusters: If using an even number of balusters, the balusters will start 3-1/4" either side of center, with all balusters 6-1/2" on-center. Mark both rails 6-1/2" on-center, starting from the desired location.*

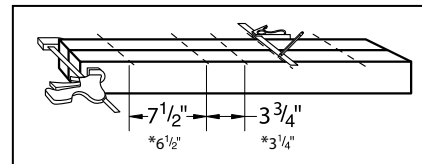

Step 3: Screw on one Deckorators Scenic baluster connector (sold separately) on each mark, using the screws provided.

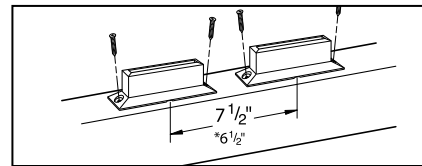

Step 4: Place the bottom rail between the rail posts, supported by a 3" block (2x4 scrap material works best). Secure rail to posts using Deckorators rail connectors (sold separately). Insert one Scenic Baluster into each baluster connector.

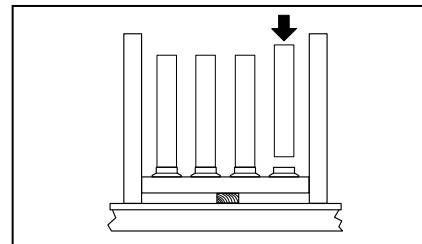

Step 5: Carefully place top rail over the balusters, making sure each baluster is seated properly in each baluster connector. Inspect finished railing for proper baluster spacing and secure top rail to posts. Attach support blocks to the bottom of the lower rail an equal distance from each post.

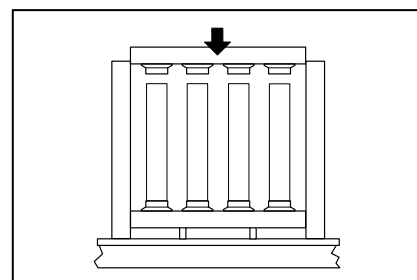

STAIR RAILING

Step 6: Follow Step 1 and cut top and bottom rails to length, with proper angle. Clamp together and mark top and bottom rails every 9" on-center.

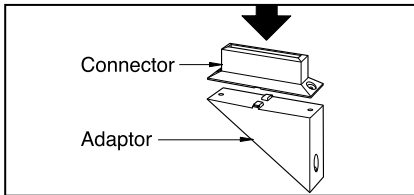

Step 7: Deckorators Scenic baluster stair connectors (sold separately) are composed of two parts: the connector and the adaptor. To install, place the connector on the adaptor, being sure the groove in the connector matches up with the knobs on the adaptor. Position one connector and adaptor on each mark and attach to the rail using the screws provided. Scenic baluster stair connectors work for 35-degree stair angles.

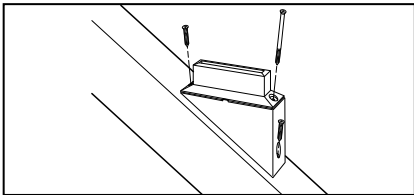

Step 8: Attach bottom rail to post. Insert one Scenic Baluster into each baluster stair connector. Carefully place top rail over the balusters, and secure top rail to post.

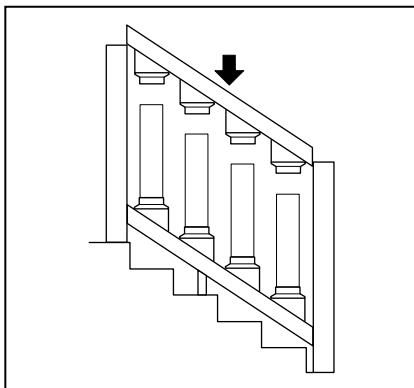

THE DIAGRAMS AND INSTRUCTIONS IN THIS BROCHURE ARE FOR ILLUSTRATION PURPOSES ONLY AND ARE NOT MEANT TO REPLACE A LICENSED PROFESSIONAL. ANY CONSTRUCTION OR USE OF THE PRODUCT MUST BE IN ACCORDANCE WITH ALL LOCAL ZONING AND/OR BUILDING CODES. THE CONSUMER ASSUMES ALL RISKS AND LIABILITY ASSOCIATED WITH THE CONSTRUCTION OR USE OF THIS PRODUCT. THE CONSUMER OR CONTRACTOR SHOULD TAKE ALL NECESSARY STEPS TO ENSURE THE SAFETY OF EVERYONE INVOLVED IN THE PROJECT, INCLUDING, BUT NOT LIMITED TO, WEARING THE APPROPRIATE SAFETY EQUIPMENT. EXCEPT AS CONTAINED IN THE WRITTEN LIMITED WARRANTY, THE WARRANTOR DOES NOT PROVIDE ANY OTHER WARRANTY, EITHER EXPRESS OR IMPLIED, AND SHALL NOT BE LIABLE FOR ANY DAMAGES, INCLUDING CONSEQUENTIAL DAMAGES.